

# USPC-SSS-4024-20-4" SQR - .240"

## Square Straight Steel Pole

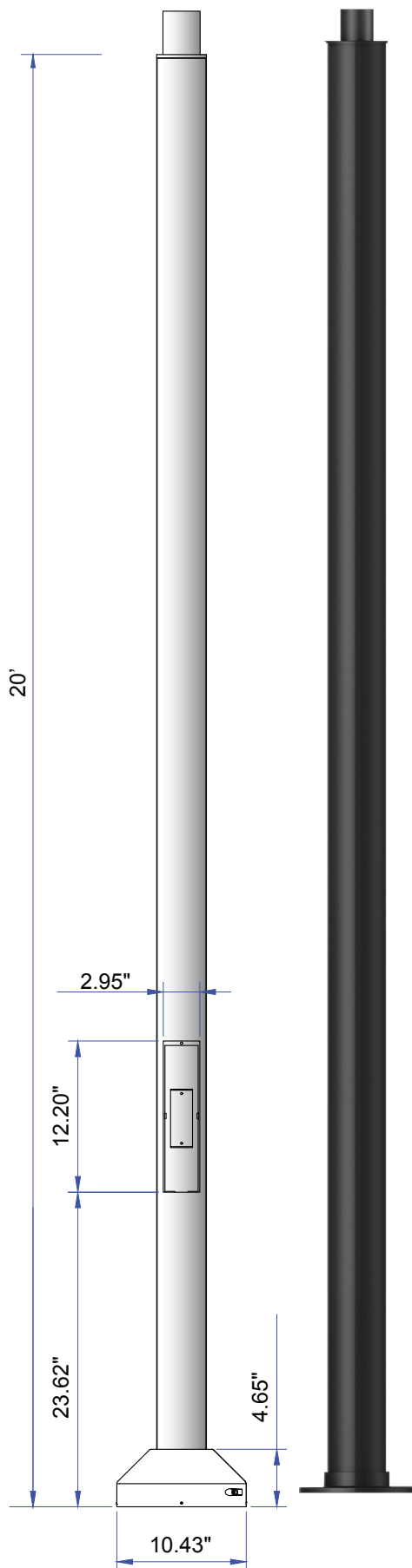

### Tenon Post Top

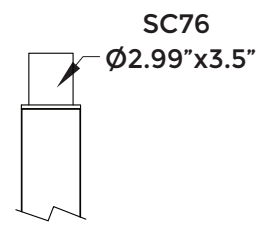

### Physical Data

Pole Height: 20'  
 Pole Size: 4" x 4"  
 Thickness: 0.240"  
 Weight: 250 lbs

### Pole Mount Install Notes

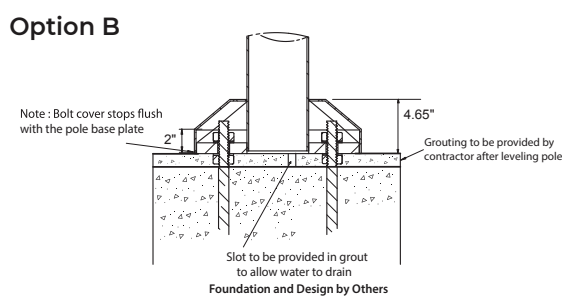
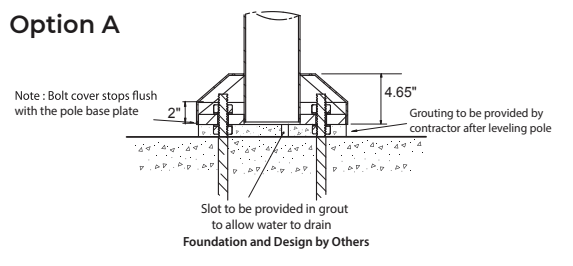

### Anchor Bolt

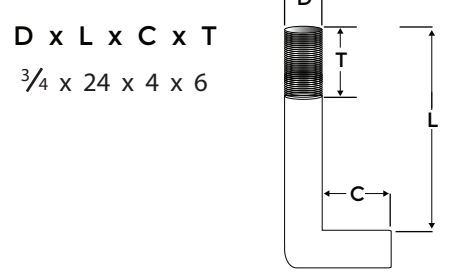

### Bolt Projection

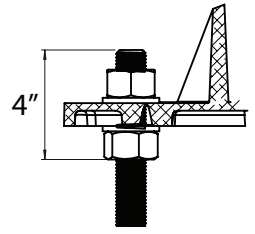

### Mounting Base

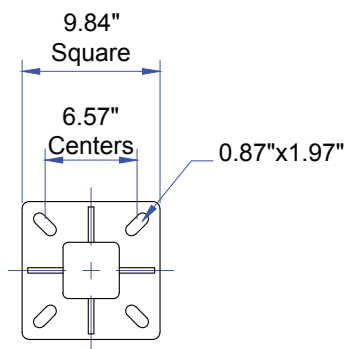

### Die-Cast Base Cover



### Maximum EPA

MPH	90	100	110	120	130
EPA	25.5	20.0	18.5	13.2	10.7

### Wind Load Map



Ligman Lighting USA reserves the right to change specifications without prior notice, please contact factory for latest information. Due to the continual improvements in LED technology data and components may change without notice.

# USPC-SSS-4024-20'-4" SQR - .240"

## Square Straight Steel Pole



<b>PROJECT</b>		<b>DATE</b>	
----------------	--	-------------	--

<b>QUANTITY</b>		<b>TYPE</b>		<b>NOTE</b>	
-----------------	--	-------------	--	-------------	--

### ORDERING EXAMPLE || USPC-SSS-4024-20'-4" SQR .240"-SC76-02-Options

--	--

<b>TENON</b>	<b>FINISH COLOR</b>
--------------	---------------------

- SC76 - 2.99" x 3.5" Tenon
- 01 - BLACK RAL 9011
  - 02 - DARK GREY RAL 7043
  - 03 - WHITE RAL 9003
  - 04 - METALLIC SILVER RAL 9006
  - 05 - MATTE SILVER RAL 9006
  - 06 - BRONZE RAL 6014
  - 07 - CUSTOM RAL

--	--	--	--

### ADDITIONAL OPTIONS - CONSULT FACTORY FOR PRICING

SBA - Single Banner Arm  
 DBA - Double Banner Arm  
 GFCI - GFCI Box

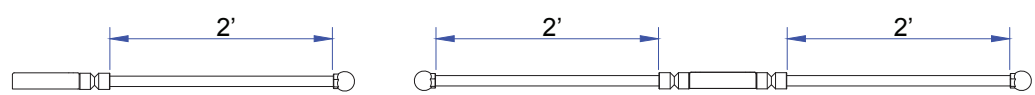

**SBA**  
Single Banner Arm

**DBA**  
Double Banner Arm

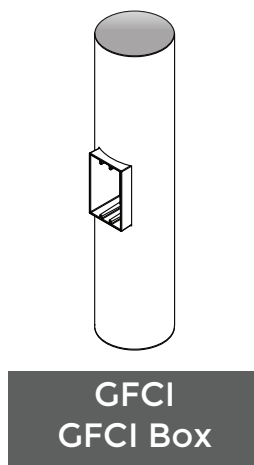

Banner arms are designed with a safety break-away at the clamp with an internal safety wire that prevents the arm from falling to the ground.

### Not to scale template:

This drawing is being furnished for reference dimensions only and cannot be used as a template to set anchor bolts. Since it is "not to scale" Ligman accepts no responsibility for its intended use. Refer to site plans and specification before installing any anchor bolts.

• Contact Ligman Lighting USA for bolt template prior to pouring anchor bolts.